

Reference Manual

Solaira

ICR Series H3

TRIPLE EMITTER
CANADA & USA MODELS:

<u>STANDARD</u>	&	<u>CANDEL</u>	
SICR45240-C	&	SICR45240LL-C	3375W - 208V / 4500W - 240V (SINGLE PHASE)
SICR60240-C	&	SICR60240LL-C	4500W - 208V / 6000W - 240V (SINGLE PHASE)

C = COLOR CODE



SHORTWAVE INFRARED HEATERS FOR:
INDOOR USE - COMMERCIAL AND INDUSTRIAL ONLY
OUTDOOR USE - RESIDENTIAL, COMMERCIAL AND INDUSTRIAL

⚠ FOR USE IN NON-HAZARDOUS AREAS ONLY ⚠ ⚠



INFORESIGHT CONSUMER PRODUCTS INC.

125 Traders Blvd. E Unit # 4, Mississauga, Ontario L4Z 2H3

Tel: 905-568-7655 - Fax: 905-568-7521

Email: info@solairaheaters.com - Website: www.solairaheaters.com

⚠ IMPORTANT - SAVE THESE INSTRUCTIONS FOR FUTURE REFERENCE



IMPORTANT INSTRUCTIONS



When using electrical INFRARED HEATERS, basic precautions should always be followed to reduce the risk of fire, electric shock, and injury to persons, including the following:



1. **Read all instructions before using this heater.**
2. Use this heater only as described in this manual. Any other use not recommended by the manufacturer may cause fire, electric shock, or injury to persons.
3. This heater is hot when in use. To avoid burns, do not let bare skin touch hot surfaces. If provided, use handles when moving this heater. Keep combustible materials, such as furniture, pillows, bedding, papers, clothes, and curtains at least 6 feet (1.8m) from the front of the heater and keep them away from the sides and rear.
4. Extreme caution is necessary when any heater is used by or near children or invalids and whenever the heater is left operating and unattended.
5. Do not operate any heater with a damaged cord or plug or after the heater malfunctions, has been dropped or damaged in any manner. Return heater to authorized service facility for examination, electrical or mechanical adjustment, or repair.
6. This heater must not be used in bathrooms, laundry areas and similar locations.
7. Do not run cord under carpeting. Do not cover cord with throw rugs, runners, or the like. Arrange cord away from traffic area and where it will not be tripped over.
8. To disconnect heater, if hard wired switch off breaker. Connect to grounded CFI outlets only.
9. Connect to properly grounded outlets only.



IMPORTANT INSTRUCTIONS



10. Do not insert or allow foreign objects to enter any opening as this may cause an electric shock or fire, or damage the heater.
11. To prevent a possible fire, do not block openings in any manner.
12. A heater has hot parts inside. Do not use it in areas where gasoline, paint, or flammable liquids are used or stored.
13. Avoid the use of an extension cord because the extension cord may overheat and cause a risk of fire.
14. Do not cover or otherwise obstruct the heater.
15. Do not touch the heater during operation as the body becomes hot and could cause burns. Particular attention has been given where children and vulnerable people are present.



SAVE THESE INSTRUCTIONS



GROUNDING INSTRUCTIONS

For 240 (or 208) volt heaters. The cord must be hard wired.



WARNING: RISK OF FIRE



Keep combustible material such as furniture, papers, clothes and curtains at least 6 feet (1.8m) from the front of the heater and away from the sides and rear.
Do not use as an indoor residential or household heater.

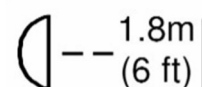



INTRODUCTION

The Solaira ICR Series H3 heater produces radiant heat like the sun, warming people and objects rather than the air in between. It is mounted on an adjustable bracket that allows the heat to be directed exactly where it is required. The Solaira ICR Series H3 heater is designed for outdoor and indoor use.

Please read the following instructions carefully before use. The safety of this heater is guaranteed only by its correct usage in accordance with these instructions, therefore they should be retained for future reference.

CAUTION

Before using this appliance:

1. Check that the voltage indicated on the units rating label corresponds to the mains supply voltage.
2. Do not install the heaters less than the minimum height from the floor, distance to ceiling and distance to side walls as specified in Table. 1.
3. Ensure that the heater has been securely fastened in its final mounting position.
4. **WARNING** - This appliance must be grounded! 
5. **WARNING** - Keep the mains cord away from the body of the heater.
6. If a socket outlet is used do not position the outlet immediately above or behind the heater.
7. Avoid the use of an extension cord with this product.
8. Do not cover or obstruct the heater at any time.
9. Do not insert any object through any slot or opening in the heater.
10. Do not use if a guard is not present.
11. **WARNING** - When replacing the emitter or cleaning the unit, ensure that the hard wired circuit is disconnected from the mains supply. **NOTE: ALWAYS ENSURE THAT THE EMITTER IS COOL BEFORE HANDLING.**
12. Do not handle the halogen emitter with bare hands. If it is inadvertently touched, remove finger marks with a soft cloth and methylated spirit or rubbing alcohol. Otherwise, the marks will burn into the quartz emitter during use causing premature heater failure. 
13. The heater is not intended for use by young children and must be supervised by a responsible person at all times. 

SPECIFICATION

Table 1. Canada and USA Heaters

Model Types	SICR45240-C & SICR45240LL-C	SICR60240-C & SICR60240LL-C
Voltage	208V / 240V	
No. of Emitters × Power	3 × 1500W	3 × 2000W
Total Power	3375W / 4500W	4500W / 6000W
Current	16.2A / 18.8 A	21.6A / 25.0A
Min. mounting height from floor	98¼ in / 108 in (250cm / 274cm)	108 in / 120 in (274cm / 305cm)
Min. distance from ceiling 	6in (15cm)	
Min. distance from side wall	59in (150cm)	
Dimensions - W × H × D	50in × 10in × 4½in (128cm × 26cm × 12cm)	
Weight	17.6lbs (8.0kg)	

 **WARNING - RISK OF FIRE:** Do not use as an indoor residential or household heater.

INSTALLATION

The 208V / 240V heaters are fitted with 6 feet, 7 inches (2.0m) of supply cable for hard wiring.

 **WARNING:** Wiring procedures and connections should be in accordance with the National Electric Code (NEC) and local codes.

 **WARNING:** If the supply cord becomes damaged, it must be immediately replaced by a qualified person.

 **CAUTION:** Disconnect electric power supply before working on circuit wiring to prevent electric shock.

 **CAUTION:** Please observe the minimum safe distance between the heater body and any inflammable surfaces.

 **CAUTION:** When installing outdoors we recommend the heater is positioned where it will be protected from exposure to extreme weather such as snow and ice.

 **CAUTION:** When the electrical connection is outside a weatherproof socket must be used having ground fault protection (GFCI or GFI).

! NOTE: IF IN DOUBT, CONSULT A QUALIFIED ELECTRICIAN.

MOUNTING - WALL MOUNTED

CAUTION

Always isolate the heater from the mains supply when mounting or adjusting the heater position.

- NOTE: The minimum safe mounting distance between the heater body and inflammable surfaces must be observed. Please refer to Table 1 for the positioning of the heater with regards to minimum distances. Do not install the heater in a corner! If installing near a corner, always ensure that the minimum side wall distance is maintained.
- Do not position the heater near to furniture or curtains as this could present a fire hazard.
- When wall mounting the heater in a horizontal manner, do not position the heater at an angle more than 75° and less than 45° when viewed from the side as shown in Fig. A.
- Always allow the heater to cool before attempting to reposition/move. Never attempt to move the heater while it is switched on!

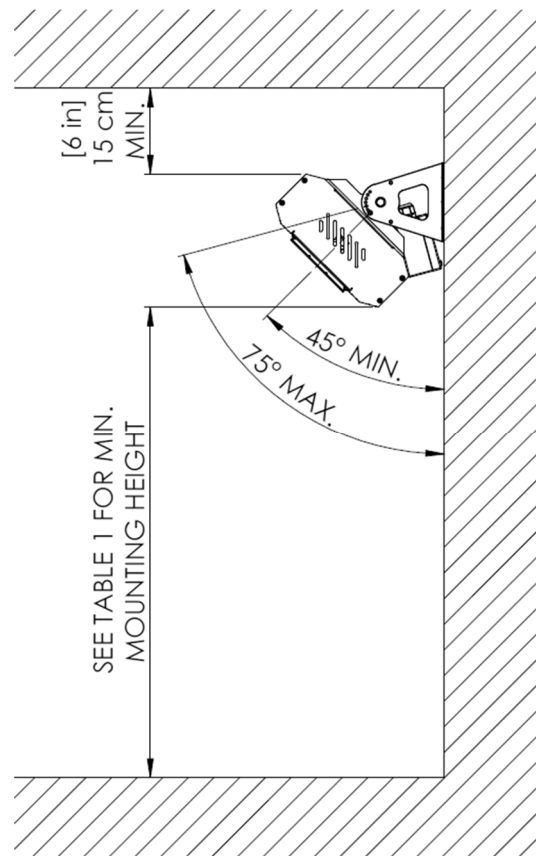

Fig. A

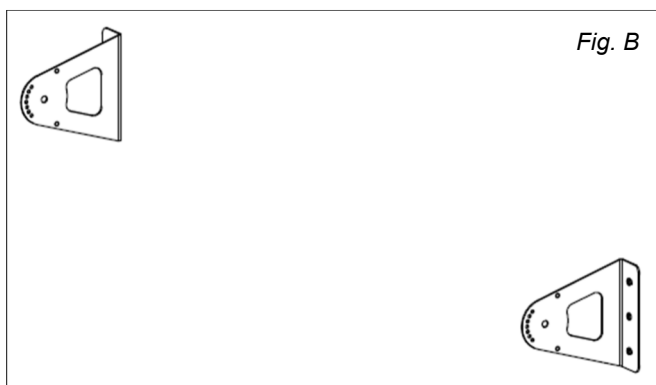

Fig. B

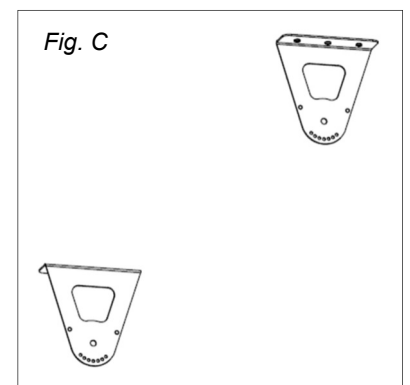

Fig. C



Fig. D

1. Securely fasten the L-shaped wall brackets to the mounting surface as shown in Fig. B (for wall mounting) or Fig. C (for overhead mounting). Refer to the mounted bracket hole centres detail in Fig. D. See Table 1 for recommended positioning of the heater.
NOTE: WALL FIXINGS ARE NOT SUPPLIED.

2. The heater should be mounted with the terminal box at the bottom of the heater when wall mounted (see Fig. E) and only mounted on horizontal/level ceilings (not sloped/vaulted) when ceiling mounting.

3. Position the heater between the two brackets and fix through the body brackets. Loosely fit the fixing bolts on the brackets at the rear of the heater as shown in Figs. E & F.

4. Fix in the desired position and tighten locking screws. Then fully tighten heater bolts.

5. Ensure the supply cable is not resting on the heater.

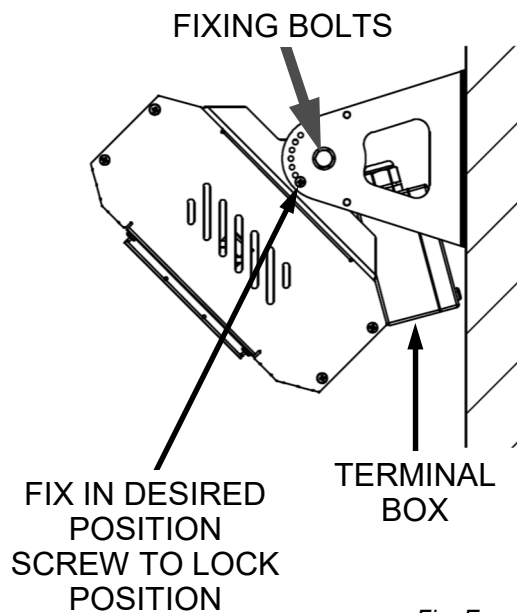

Fig. E

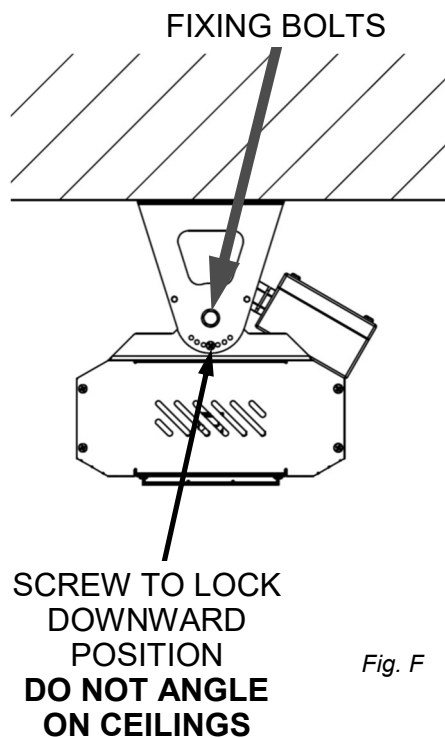

Fig. F

TYPICAL HEATER MOUNTING ARRANGEMENT

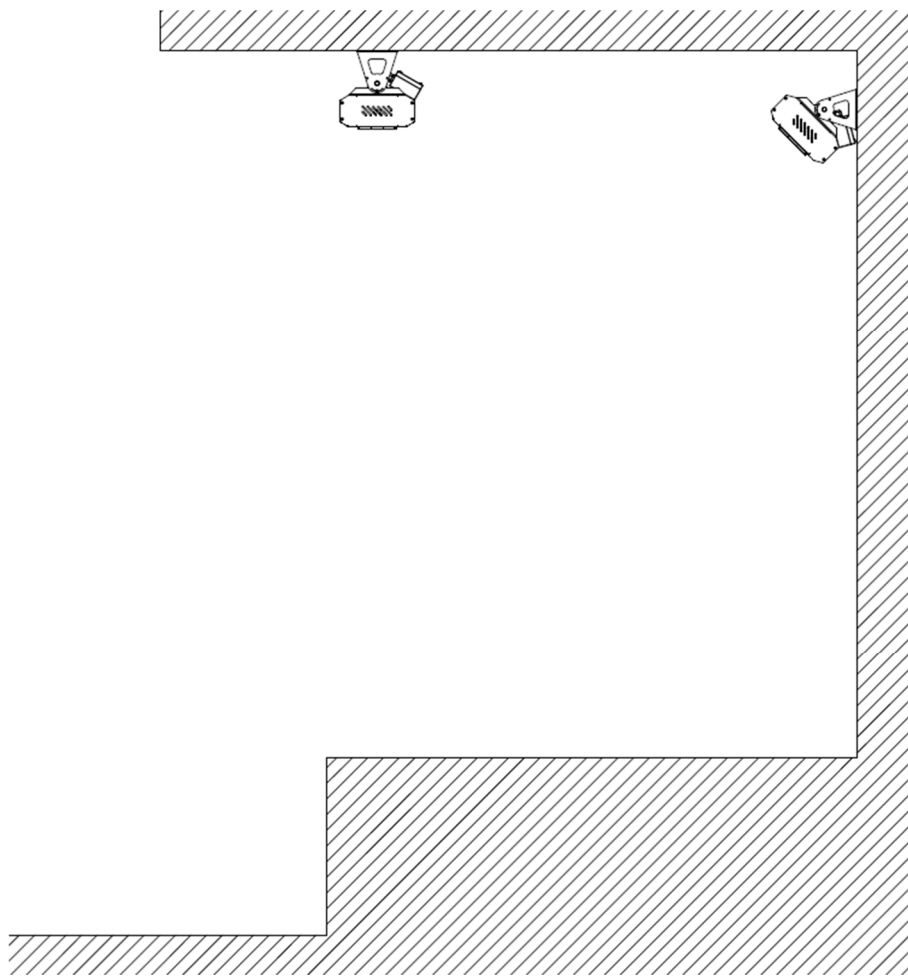

Fig. G

MOUNTING - CHAIN HUNG



Always isolate the heater from the mains supply when mounting or adjusting the heater position.

- The heater is suitable for installation on chains that are suitably fixed to a structure sufficient to hold the weight of the heater. Observe the minimum safe distance between the heater body and inflammable surfaces when mounting.
- Please refer to Table 1 for the recommended positioning of the heater with regards to minimum distances. Do not install the heater in a corner! If installing near a corner, always ensure minimum side wall distance is adhered to.
- Do not position the heater near to furniture or curtains as this would present a fire hazard.
- Always allow the heater to cool before attempting to reposition/move. Never attempt to move the heater while it is switched on!

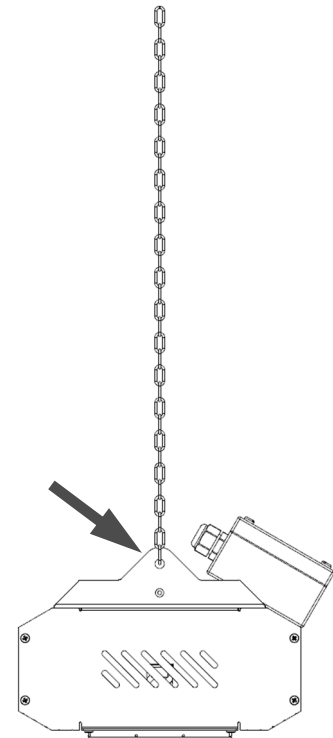

Fig. H

1. When chain hung, ensure chains are of adequate size and securely fixed to support the weight of the heater.
2. Fix the heater assembly to the chains via the holes in the centre of the body brackets if intending to face directly down as shown in Fig. H. If the heater is to be angled fix the heater to the brackets as described in the previous mounting sections and connect the chain to the centre holes on the brackets (Fig. J).
3. Ensure the supply cable does not rest on the heater.

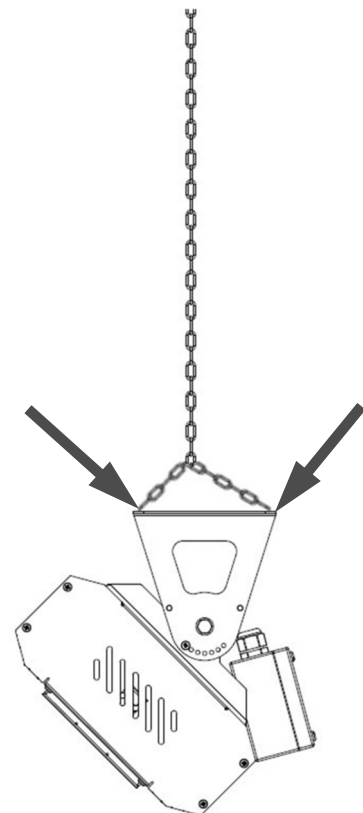

Fig. J

MOUNTING - CEILING RECESSED



CAUTION

Always isolate the heater from the mains supply when mounting or adjusting the heater position.

- See Fig. K below showing typical recessed mounting arrangement.
- Please refer to Table 1 for the recommended positioning of the heater with regards to minimum distances. Do not install the heater in a corner! If installing near a corner, always ensure minimum side wall distance is observed.
- Do not position the heater near to furniture or curtains as this would present a fire hazard.
- Always allow the heater to cool before attempting to reposition/move. Never attempt to move the heater while it is switched on!
- When recess mounting the heater it must be accompanied with a enclosure box made from a suitable material with a 1 hour fire rating and a fascia flange trim kit must be used. See Fig. L for dimensions of fascia flange trim detailing box length and width. Please note, the enclosure box and fascia flange can weigh in excess of 28 lbs (12.8 kg) so adequate structural provision is required for the installation.

TYPICAL RECESSED INSTALLATION

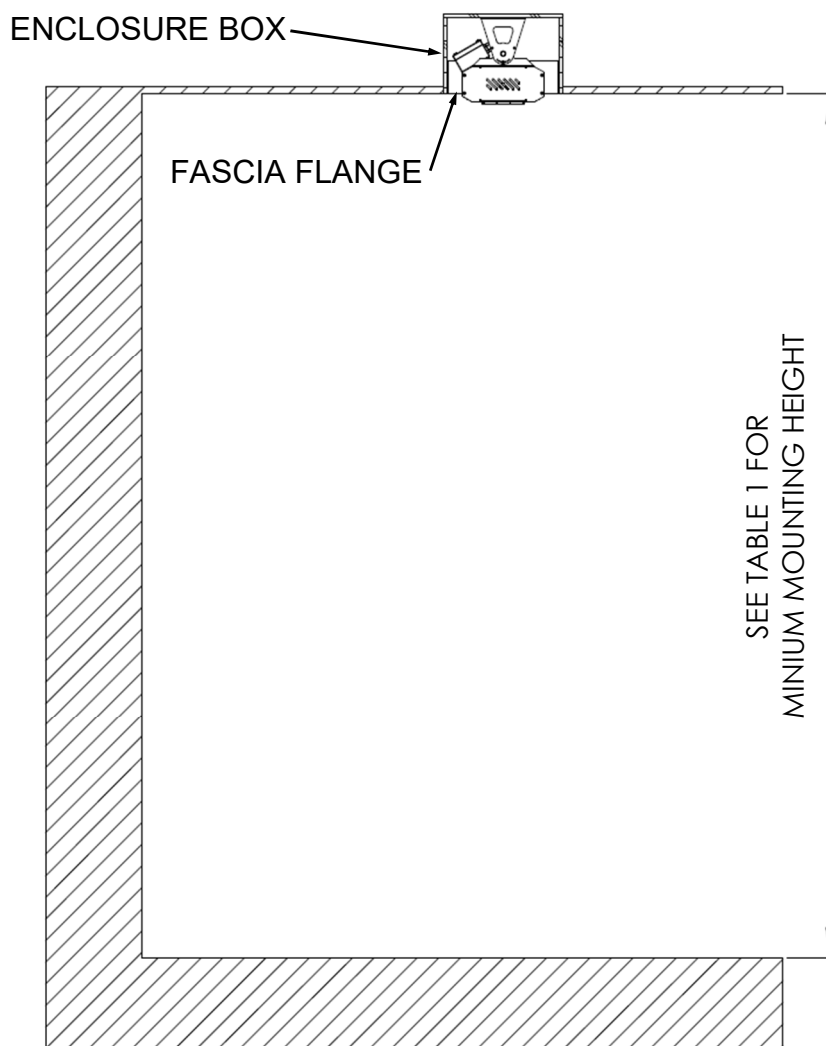

Fig. K

DIMENSIONS OF FLANGE TRIM FOR ENCLOSURE BOX

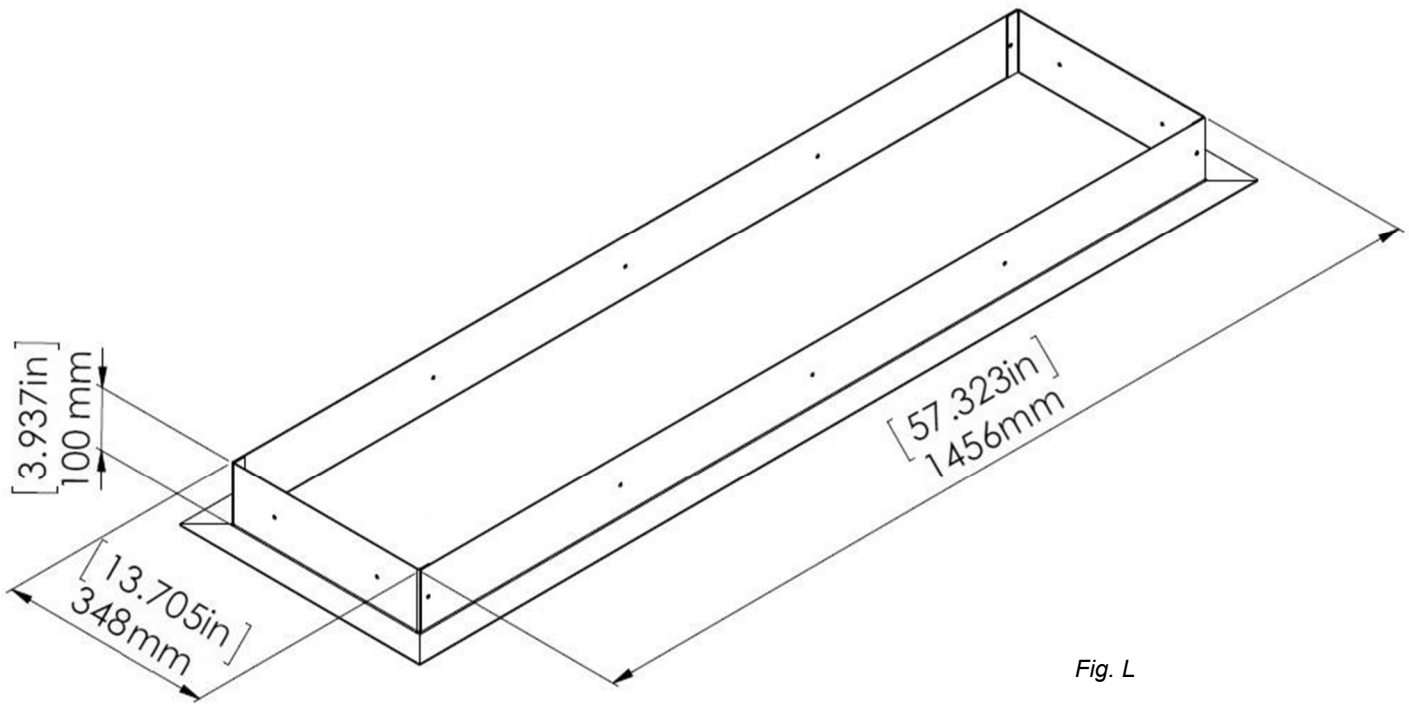

Fig. L

KIT OF 4 × SIDES SHOWN AS ASSEMBLED

TYPICAL INSTALLATION*

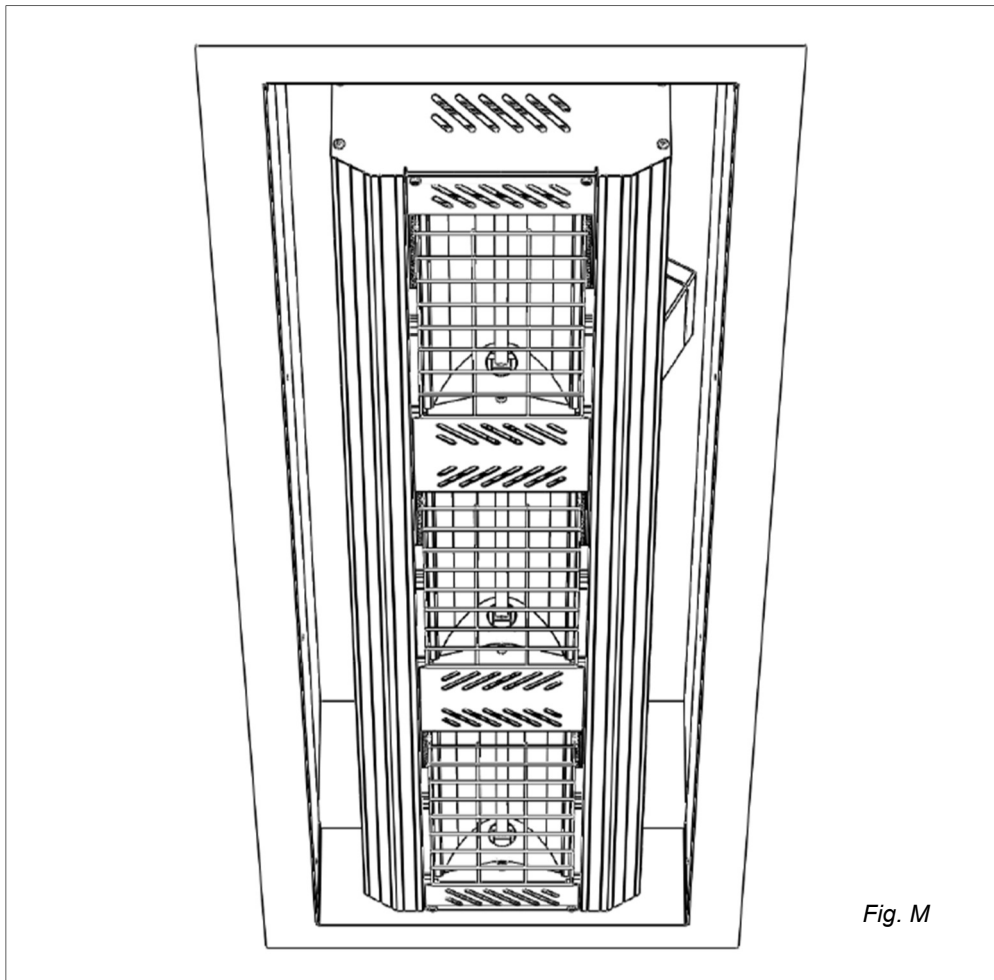

Fig. M

*Horizontal/level ceilings only. Not suitable for sloped/vaulted ceilings.

MAINTENANCE

In the event of heater failure or for spare parts or advice, please contact your service agent.

⚠ CAUTION: Always isolate the mains power from the heater or heater assembly before replacing lamp emitters or any maintenance procedure including cleaning.

⚠ CAUTION: To ensure optimum heat effectiveness, it is recommended that the grille is removed and gently wipe the reflectors with a soft cloth. The lamp emitter may also be carefully wiped. Please take care not to touch the lamp emitter with bare hands.

YOUR REPLACEMENT LAMP EMITTER(S)

It is important that when ordering a replacement lamp emitter the heater model type is specified. Failure to fit the correct lamp emitters will cause the heater to fail and become dangerous in use. Please contact your service agent to purchase your replacement lamp emitters.

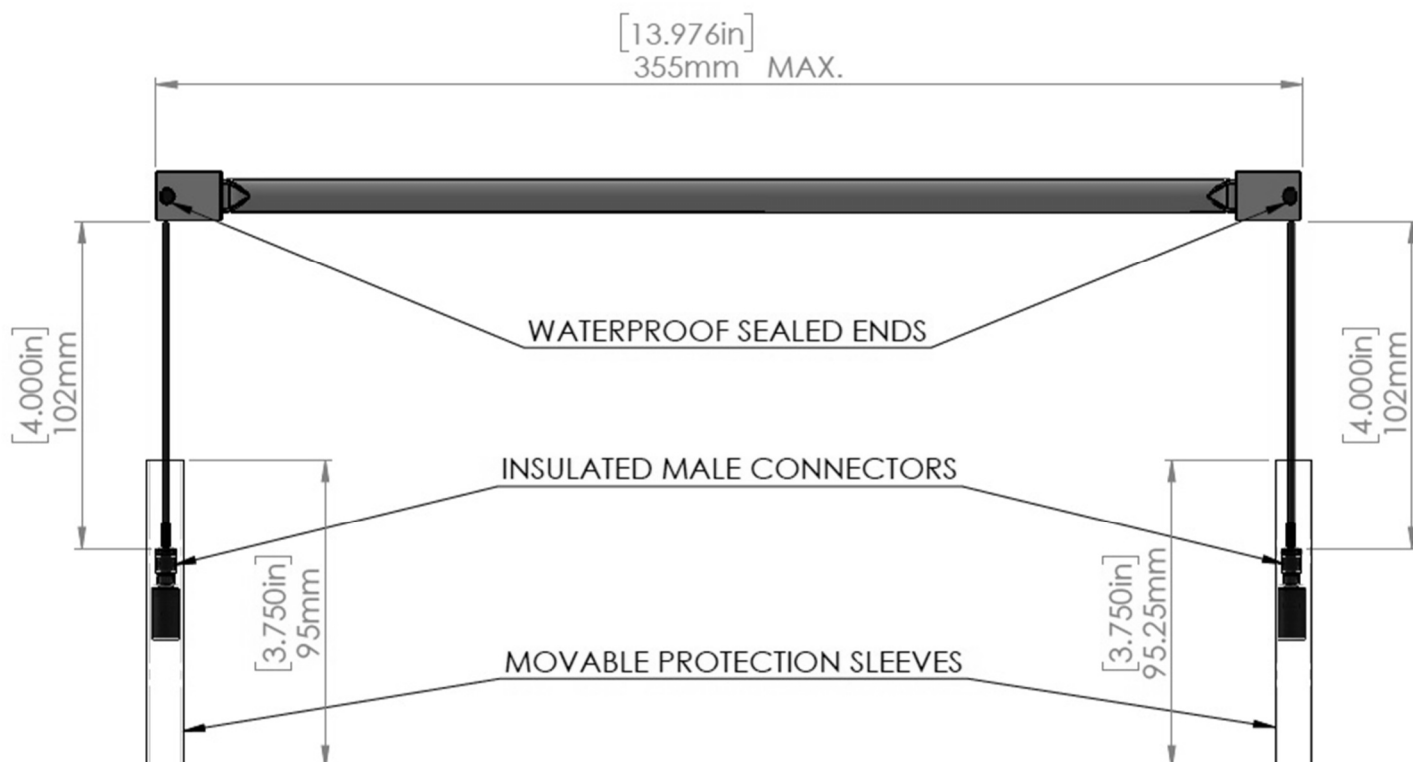

HANDLING A REPLACEMENT LAMP EMITTER

Your new lamp emitter should be handled with care and without touching the quartz glass with bare hands. A cotton glove may be used for this purpose. Remove any finger marks with a soft cloth and methylated spirits or rubbing alcohol. Finger marks will burn into the lamp emitters quartz glass causing premature failure.

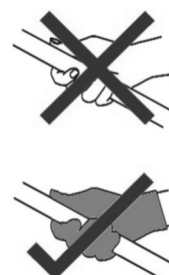

REPLACING THE EMITTER

CAUTION

Disconnect from the mains power to the heater power before any attempts are made to replace the lamp emitter. Contact your service agent for the correct replacement lamp emitter quoting model type and rating from rating label. It is important that you read through the lamp emitter replacement procedure before commencing.

1. Disconnect the power supply to the heater.
2. Remove desired guard by flexing one end and releasing from it's locating holes.
3. Remove the three screws from the front cover(s) (Fig. N) and two screws from the middle cover(s) as shown in Fig. P.



4. Slide the protection sleeving (Fig. P) downwards to reveal the quick-fit female/male connector. Holding the two connector halves as shown in Fig. Q (don't hold by the wires), gently pull apart in the direction shown in Fig. R to separate the connection as shown in Fig. S and Fig. T. Repeat at opposite end.

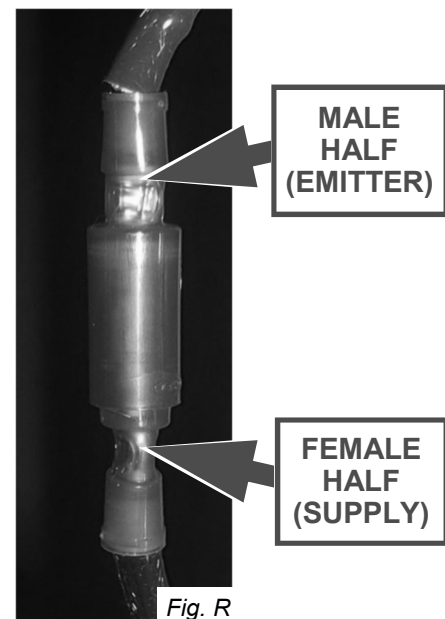
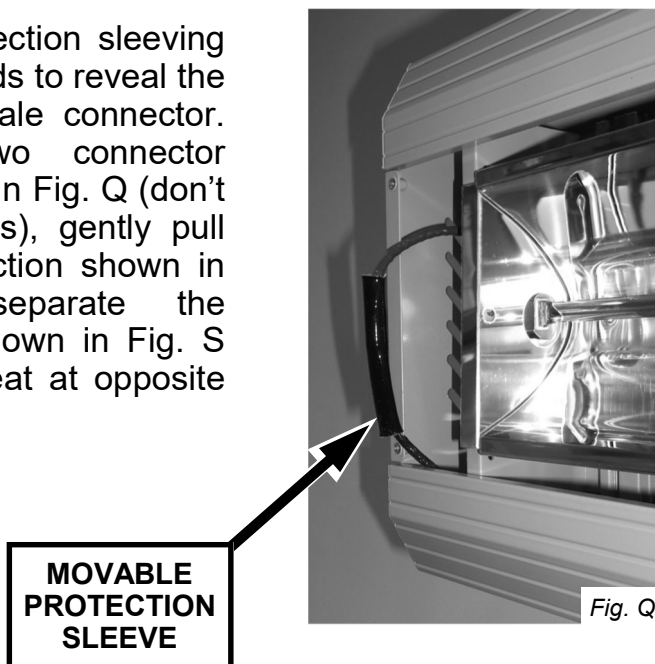

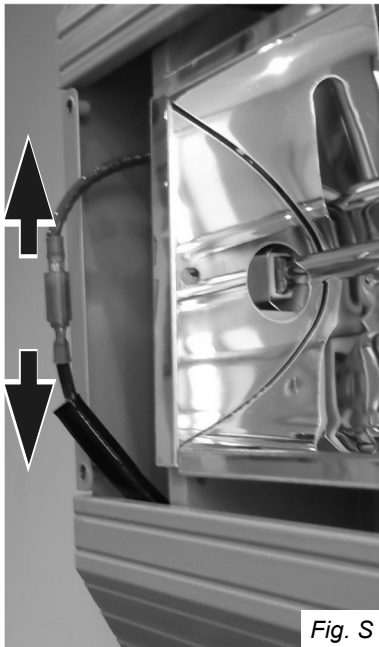

Fig. S

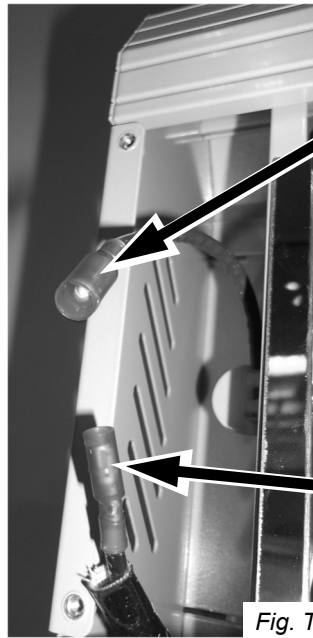

Fig. T

**MALE
CONNECTOR
FROM LAMP
EMITTER WIRE**

**FEMALE
CONNECTOR
FROM LIVE
SUPPLY**

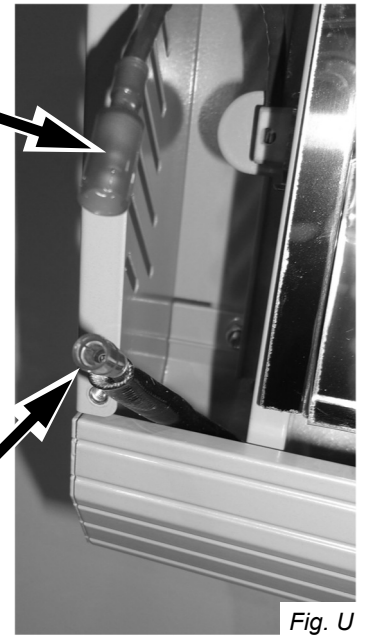

Fig. U

5. Remove the lamp emitter holding clips (Fig. V) by squeezing the clip together and lifting away as shown in Fig. W.

6. Slide the lamp emitter out through the extrusion feeding one way first with the wire and then the opposite way to take out and remove. Take care not to scratch the reflector surface.

7. Refit the new lamp emitter. Take care not to mark the reflector or touch the new lamp emitter with the hands (see note on page 11).

8. Replace the lamp emitter holding clips. Make sure they are firmly in place over the white ceramic ends of the lamp emitter.

9. Refit the male and female connectors by fully pushing together. Cover and refit the protection sleeves.

10. Replace the front side covers and middle cover in reverse order and then refit the wire guard(s).

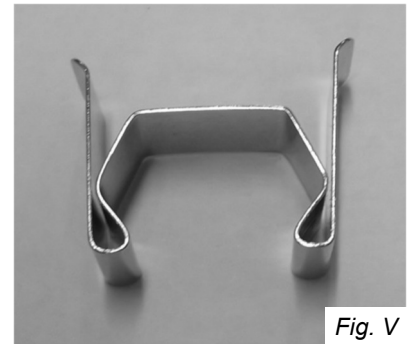

Fig. V

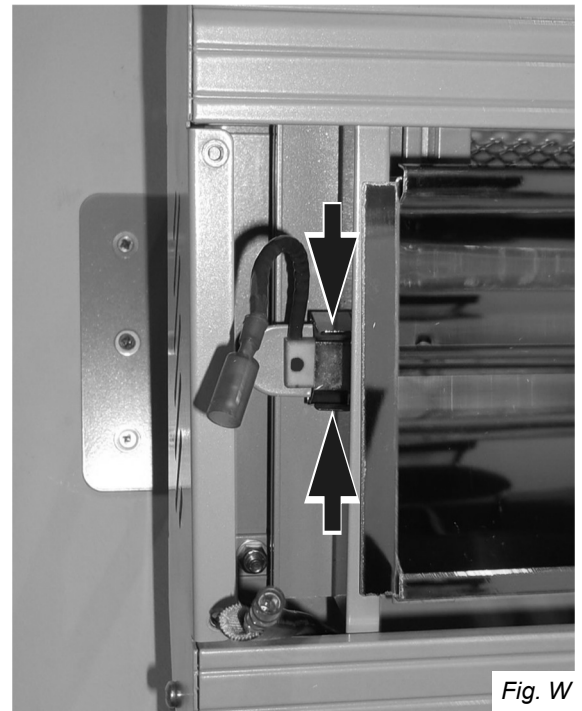

Fig. W

Solaira ICR Series H3



**SHORTWAVE INFRARED HEATERS FOR:
INDOOR USE - COMMERCIAL AND INDUSTRIAL ONLY
OUTDOOR USE - RESIDENTIAL, COMMERCIAL AND INDUSTRIAL
⚠ FOR USE IN NON-HAZARDOUS AREAS ONLY ⚠ ⚠**



**IMPORTANT - SAVE THESE
INSTRUCTIONS FOR FUTURE REFERENCE**



**CAN/CSA-C22.2 No. 46-13
UL 2021 4th Edition**

INFORESIGHT CONSUMER PRODUCTS INC.

125 Traders Blvd. E Unit # 4, Mississauga, Ontario L4Z 2H3

Tel: 905-568-7655 - Fax: 905-568-7521 - Email: info@solairaheaters.com - Website: www.solairaheaters.com

Due to our policy of ongoing improvement, we reserve the right to make changes without notice.

© 2021 INFORESIGHT CONSUMER PRODUCTS INC.

Ref No. 043139-EN Issue No. 4