

Solaira SMaRT 34-DV Variable Controller Installation & User Manual

KEEP THESE INSTRUCTIONS FOR FUTURE REFERENCE



SAFETY WARNING



ALL INSTALLATIONS/SERVICE MUST ONLY BE PERFORMED BY A LICENSED/CERTIFIED ELECTRICIAN TO LOCAL AND NATIONAL ELECTRICAL CODE (NEC).



WARNING: SHOCK AND FIRE HAZARD:



- Serious injury or death could occur
- Disconnect ALL power sources before removing cover. Power should only be re-connected after electrical installations are complete and cover replaced
- Be certain the power source conforms to specifications outlined on heater label
- Maximum heater load **SHOULD NOT EXCEED 34 AMPERE**
- Control **MUST BE PROPERLY** grounded. Assure to connect ground wire green wire from heater to ground connection from electrical supply, not to a live or “hot” conductor.
- Engineer/Electrician/Installer to determine suitability of this appliance in intended application and compliance with all local, state/provincial and National electrical Code (NEC) requirements.
- Do not use locations containing hazardous or explosive atmospheres.

ELECTRICAL RATING

Maximum load **34A @110-120V or 208-240VAC 50/60HZ**



WARNING SERIOUS INJURY OR DEATH COULD OCCUR, DISCONNECT ALL POWER PRIOR TO SERVICE



Intertek
SPE-1000 CANADA INSPECTED

Due to ongoing product improvements, specifications and dimensions are subject to change without notice and without incurring obligations.

INTRODUCTION

The Solaira SMaRT 34-DV Control has a 1 to 5 step setting allowing you to find the optimum comfort setting in your specific area.

To increase output to full output, press and release red  button.

To increase in increments, press and hold the red  button until the desired number is reached.

To reduce output to OFF, press and release red  button.

To reduce in increments, press and hold the red  button until the desired number is reached

FEATURES

- Variably control your Solaira^o heaters, up to a max load of 34A.
- Weatherproof control for exposed, wet conditions (it is the electrician responsibility to assure correct water tight connection, this may necessitate replacing included watertight strain relief)
- Variable Control – Ability to adjust output to desired comfort level
- Soft Start – zero current switching point which can extend emitter lamp life
- Temperature Monitoring – Solaira SMaRT 34-DV Variable control is equipped with a local (on controller) temperature monitor. This will allow user to pre-set the minimum temperature level that will allow the controller to operate.

Note: the temperature monitor is calibrated in Celsius; please use the following table to aid in set up:

Fahrenheit	Celsius	Fahrenheit	Celsius
32.0	0.0	55.0	12.8
36.0	2.2	60.0	15.6
40.0	4.4	65.0	18.3
45.0	7.2	70.0	21.1
50.0	10.0	75.0	23.9
		80.0	26.7

OPTIONAL ACCESSORIES (Sold Separately)



WARNING: The SMaRT-34DV can be used with the following approved accessories. Use of any other control interface is not recommended.

- **Handheld IR Remote (SMRTVMT):** Is an optional handheld remote that communicated via IR to either the SMaRT Controller or Optional Wall Switch (SM-WSD). Must be in line of sight of the controller.
- **Wall Switch (SM-WSD):** Is a mounted wall switch unit that provides control of a the SMaRT-34DV, that may be remotely located. The remote-control wall switch unit is supplied mounted on a single gang faceplate, ready to be fitted to a single gang certified J-box. As supplied the unit must be installed indoors in a dry environment, if the unit needs to be installed outdoors or in a wet environment it must be installed onto a certified J-box, which is itself installed inside a water resistant, IP65 rated enclosure

Due to ongoing product improvements, specifications and dimensions are subject to change without notice and without incurring obligations.

and to all appropriate local and NEC codes. The SM-WSD can also interface with the Handheld IR Remote SMRTVMT, which must be in line of sight of the SM-WSD.

- **Occupancy Sensor (SMRTOCC):** A passive infrared (PIR) external sensor, with a range of approximately 12m, can monitor the selected area ensuring heaters only switch on when the zone is occupied.
- **Remote Temperature Monitor (SMRTVTEM-R):** The controller can be equipped with a remotely located temperature sensor that monitors the temperature of the desired zone and inhibits the heaters when the temperature exceeds a pre-determined set point of between 41°F (5°C) to 77°F (25°C).



WARNING: Use of standalone Solaira SMRTOCC40 and SMRTOCC60 are for standalone controls ONLY and may not be paired with SMaRT34-DV. FAILURE TO COMPNY MAY RESULT IN CONTROLLER DAMAGES.



WARNING: Solaira SMaRT 34-DV Variable control is a high power electrical device and MUST ONLY BE INSTALLED BY A CERTIFIED ELECTRICIAN TO LOCAL AND NATIONAL ELECTRICAL CODE.

INSTALLATION

The control can be installed in a convenient VENTED location and does not have to be installed in the immediate area of the heaters. The unit is shipped with the Occupancy sensor input fitted with a wire link which continually re-triggers the "ON" timer so that it never expires.

If the user decides to utilize the optional Occupancy Sensor (Sold Separately), the occupancy monitor should be mounted 8' (2.5 + Meters) above of the floor. Ceiling mounting is preferred but not essential. The optional Occupancy Sensor must not be mounted directly in line with the heaters output, highly reflective surfaces, radiators or other thermostatically controlled heaters or open doorways with people walking past.



WARNING: CONTROLLER MOUNTING

DO NOT mount the controller directly on any flammable material i.e. wood or any other combustible. Controller must be mounted via standoffs (supplied & specified by others) to aid in heat dissipation, as per local building and NEC code.

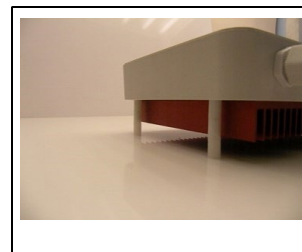

INITIAL START UP WITH OPTIONAL OCCUPANCY SENSOR

- Occupancy Sensor (SMRTOCC) (sold separately), it takes 60 seconds to set before detection takes place
- Optional Occupancy Sensor continues to monitor the area and will reset to the set time every time it detects movement.
- Before testing ensure the wiring is correct.
- Temperature trip point has already been pre-set at the factory.
- Timer is preset to 1 minute but can be adjusted using timer trimmer potentiometer to 1-60 minutes.
- The expected detection area can now be "walked tested" using the diagram shown in mind. The area should be crossed in various directions to ensure coverage is as expected.

Due to ongoing product improvements, specifications and dimensions are subject to change without notice and without incurring obligations.

DISPLAY FEATURES

Display shows 't'	The unit is turned OFF as the ambient temperature is above the trip level set by TEMPERATURE SETPOINT.
Display shows "0"	The output is OFF
Display shows "1", "2", "3", "4"	The unit is ON at the indicated power level
Display shows 'F'	The unit is set to FULL output.
Display flashing "."	The "ON" timer has expired and is waiting to be re-triggered by the Occupancy sensor (i.e. no movement detected for "ON" time)
Display "."	The unit is in Standby mode pressing the optional fully on remote control POWER button will toggle the power ON and OFF.

You can check the remote control is transmitting by observing the "." (dot) flashing rapidly.

TROUBLE SHOOTING

Heater does not come on, t in display...The heater pre-set trip temperature IS ABOVE THE AMBIENT TEMPERATURE. This can be adjusted using the temperature set point potentiometer.

Heater does not come on, flashing DOT...The controller is waiting for input from optional occupancy sensor. If your system does not utilize the occupancy sensor, then wire jumper (factory installed) must be in place in PIR SENSOR INPUT on pins SIG IN and COM. If the jumper is not in place, controller will not operate.

SPECIFICATIONS

Max load at 20°C ambient	34 Amp, 8000W @ 208-240VAC or 4000W @ 120VAC
Voltage	120Vac or 208-240Vac +/- 10%,50/60Hz
Power Consumption	50mA
Occupancy Sensor (option)	See below
Pushbutton Timer (option)	Momentary or Toggle
Set Time Period	1-60 minutes
Temperature Set point	5°C to 25°C
Factory Set Temperature trip point	25°C
2 heater Installation	Must be fitted in Parallel
Ambient Operating Temperature	-20°C to 30°C
IP Rating	IP65
Max Unit Operating Temperature	65°C

Due to ongoing product improvements, specifications and dimensions are subject to change without notice and without incurring obligations.

<i>Occupancy Monitor</i> (optional)	12V dc
Operating Voltage	90° Adjustable
Direction	45° (18 Meters)
Detection	



WARNING: Solaira SMaRT 34-DV Variable control is a high-power electrical device and MUST ONLY BE INSTALLED BY A CERTIFIED ELECTRICIAN TO LOCAL AND NATIONAL ELECTRICAL CODE

Due to ongoing product improvements, specifications and dimensions are subject to change without notice and without incurring obligations.

SMaRT 34-DV ILLUSTRATIVE WIRING DIAGRAM*

*Connection diagram is for illustrative purpose only. Installation must be carried out by certified electrician to local, state/provincial and National Electric Code (NEC) requirements. Inforesight Consumer Products Inc. assumes no responsibility for the heaters or controller electrical plan or installation.



WARNING SERIOUS INJURY OR DEATH COULD OCCUR, DISCONNECT ALL POWER PRIOR TO SERVICE

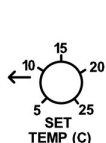
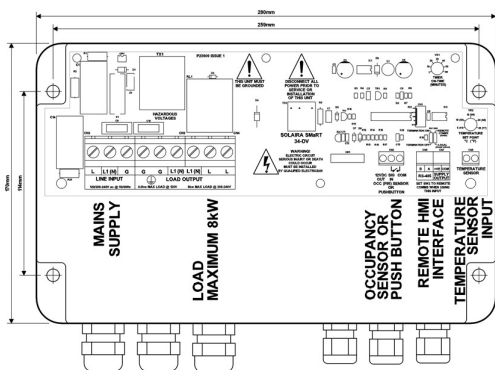

FAHRENHEIT	CELSIUS
32.0	0.0
36.0	2.2
40.0	4.4
45.0	7.2
50.0	10.0
55.0	12.8
60.0	15.6
70.0	21.1
75.0	23.9
80.0	26.7

WARNING: RISK OF INJURY OR DEATH ENSURE ALL POWER IS OFF FOR INSTALLATION OR SERVICE

*** ALL SOLAIRA HEATERS AND CONTROLLERS SHOULD BE INSTALLED BY CERTIFIED ELECTRICIANS TO LOCAL STATE/PROVINCE NEC CODE**

LINE & LOAD CONNECTION

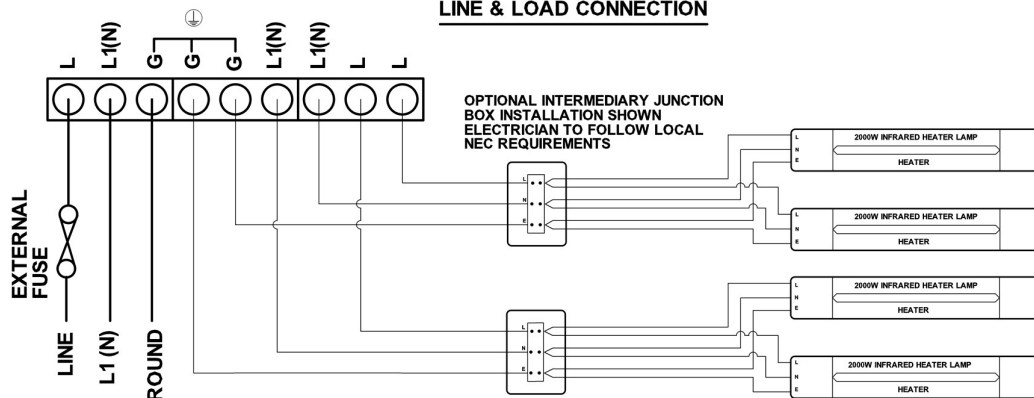

OCCUPANCY SENSOR

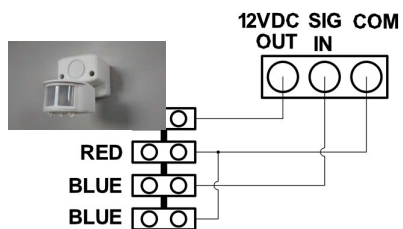

TEMPERATURE SENSOR

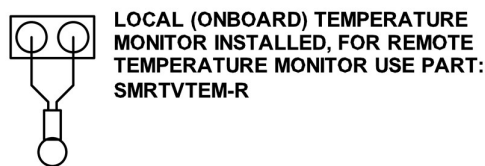

LOCAL (ONBOARD) TEMPERATURE MONITOR INSTALLED, FOR REMOTE TEMPERATURE MONITOR USE PART: SMRTVTEM-R

FRONT PANEL



FOR FULL OUTPUT DAB ▲ ONCE, DISPLAY CHANGES TO "F" TO SWITCH OFF DAB ▼ ONCE, DISPLAY CHANGES TO "0" TO CHANGE OUTPUT INCREMENTALLY PRESS AND HOLD ▲ OR ▼ AS REQUIRED



TEMPERATURE TRIP SET POINT, THE CONTROLLER SWITCHES OFF AND THE DISPLAY SHOWS "t" WHEN THE AMBIENT TEMPERATURE REACHES THIS LEVEL

TROUBLE SHOOTING

Temperature Set Point

Temperature set point allows user to control the MINIMUM TEMPERATURE for heaters to come on. If the ambient temperature is above the pre-set level, the heater control will show "t" and WILL NOT TURN ON. You can reduce the minimum temperature to 5°C

Temperature Sensor Input

For local temperature sensor input and optional remote temperature sensor input (SMRTVTEM-R). The local temperature sensor is included with all SMaRT 34-DV controllers. If the user wishes NOT to use the temperature monitoring feature, simply disconnect the temperature sensor.

FLASHING DOT ON CONTROL PANEL DISPLAY

If the controller is used WITHOUT OPTIONAL OCCUPANCY SENSOR (SMRTOCC), then "wire jumper" must be installed in pins SIG and COM as shown. If the jumper is not installed, the controller senses an open circuit and will switch OFF. Your controller comes with the jumper installed and it should only be removed when a sensor is installed.

Wire jumper installed for use WITHOUT optional Occupancy SENSOR (PIR)

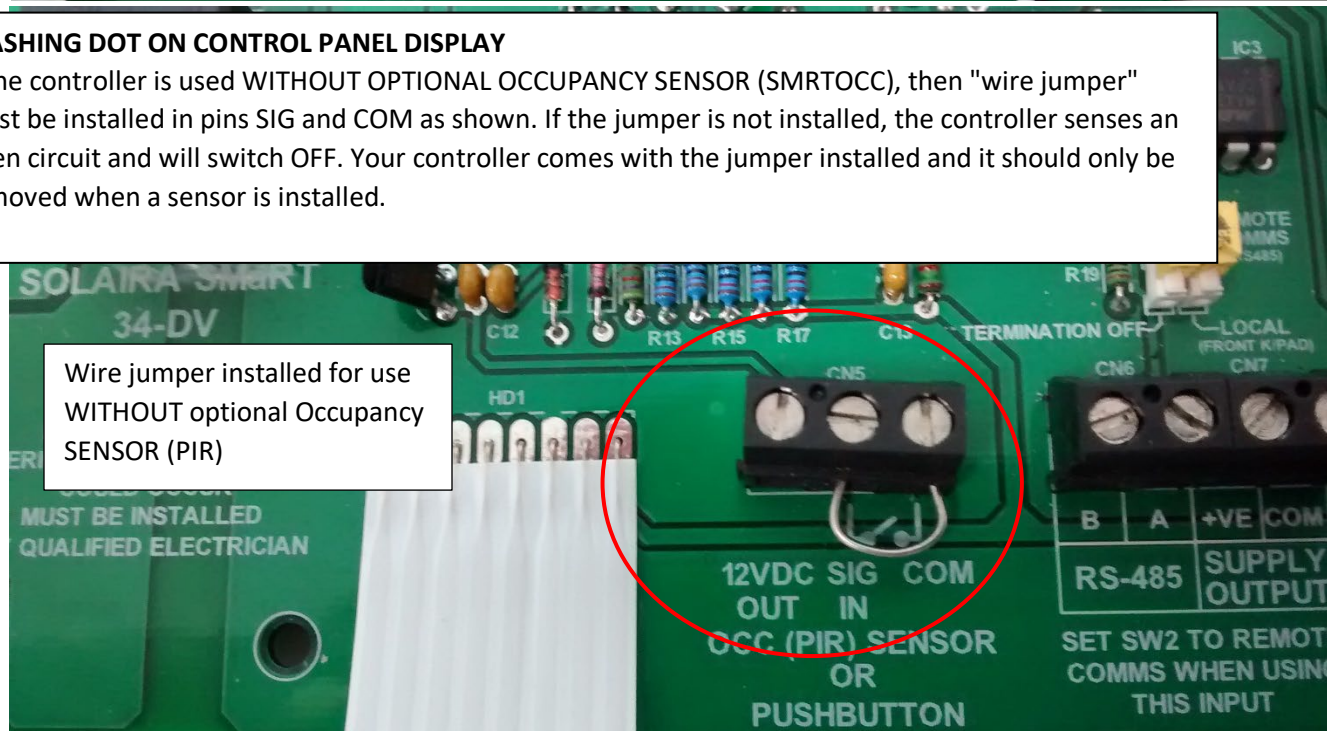
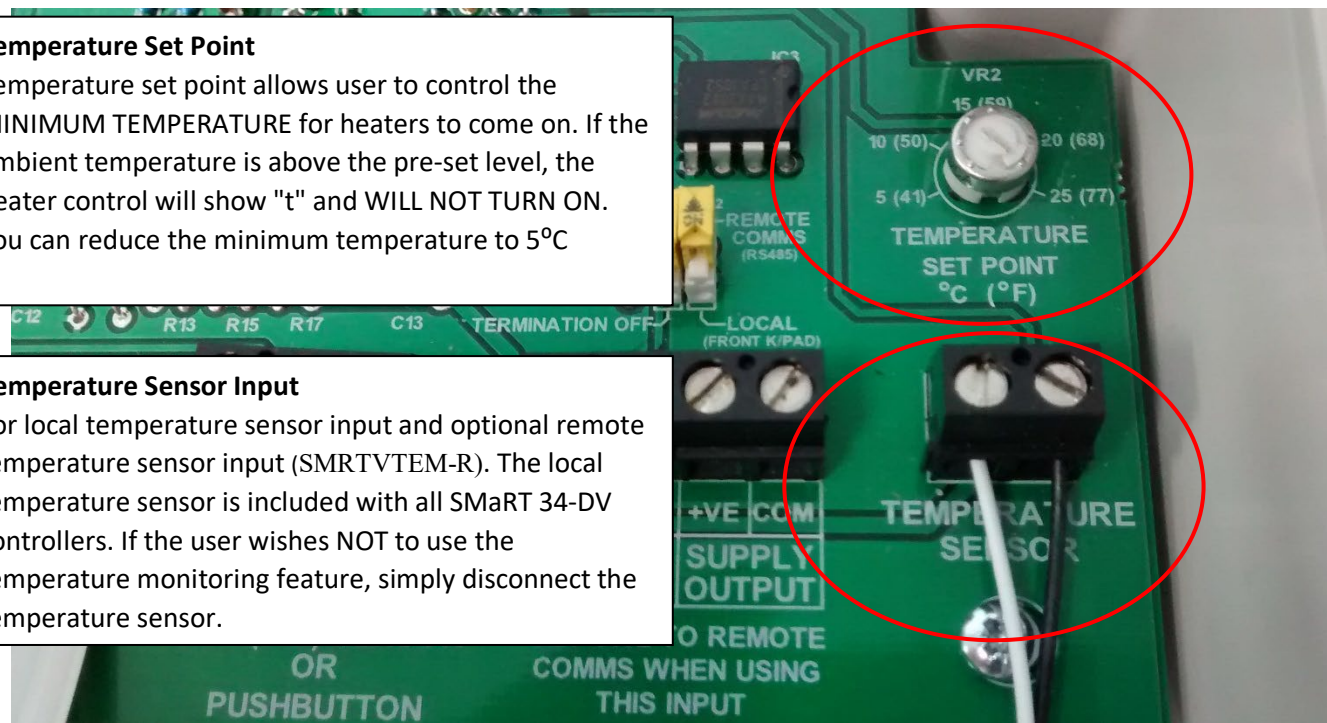

PLEASE NOTE: If you are using a **SMRTOCC** with the Solaira SMaRT 16DV and 34DV, the timer function on the **Wall Switch SM-WSD** will be overridden if the **SMRTOCC** has been activated.

If you are not using a **SMRTOCC**, the Link that is fitted as standard between the SIG IN / COM 'MUST' be removed otherwise the timer function on the **SMaRT Wall Switch SM-WSD** will not operate.

Due to ongoing product improvements, specifications and dimensions are subject to change without notice and without incurring obligations.

LIMITATION OF LIABILITY

It is understood and agreed that seller's liability whether in contract, in tort, under any warranty, in negligence or otherwise shall not exceed the return of the amount of the purchase price paid by purchaser and under no circumstances shall seller be liable for special, indirect or consequential damages. The price stated for the equipment is a consideration in limiting seller's liability. No action, regardless of form, arising out of the transactions may be brought by purchaser more than one year after the cause of action has accrued.

WARRANTY

1. SOLAIRA CONTROL products are guaranteed to be free from mechanical and electrical defects for a period of one year from date of shipment under normal use and service provided installation is made in accordance with manufacturers' recommendations.
2. Parts deemed defective shall be repaired or replaced at manufacturers option and at manufacturers expense but shall not include foreign or federal excise taxes, state or municipal sale or use taxes, all such taxes not limited to the foregoing being responsibility of the purchaser.
3. No charge for travel and/or mileage will be allowed to purchaser.
4. SOLAIRA reserves the right to make changes in design or make any improvements on any products. The right is always reserved to modify our equipment because of new technology, underwriter's requirements and/or government regulations.
5. The following are not covered under warranty:
 - a. INSTALLATION OF CONTROL BY NON-CERTIFIED ELECTRICIAN.
 - b. Failure from neglect, abuse, careless handling and mis-application of unit.
 - c. Failure to observe guidelines for installation or improper voltage hook-up.
 - d. Failure caused by improper installation and not following local, state/provincial and federal electrical guidelines
 - e. Unless specifically allowed by SOLAIRA CONTROLS, no other charges may be included under warranty.

Notice: Inforesight Consumer Products Inc. website, product information and products can be accessed from Canada and other countries around the world. Customer understands that some or all products provided by Inforesight Consumer Products Inc. may not be available for purchase or installation in certain jurisdictions or geographical areas. Inforesight Consumer Products Inc. reserves the right, in its sole discretion, to exclude or otherwise limit the provision of any product to a person or entity residing in any jurisdiction or geographical area outside of Canada. Inforesight Consumer Products Inc. provides general product information, installation guidelines and procedures and Customer understands that Customer is solely and exclusively responsible for installation of the product and ascertaining all applicable local municipal, provincial, state, and federal NEC (National Electrical Code) rules, by-law, ordinances and guidelines applicable to the installation of any Inforesight Consumer Products Inc. products. Customer must strictly adhere to and be compliant with the local rules, laws, ordinances and legal requirements for the safe installation and use of any Inforesight Consumer Products Inc. products. Instruction manuals are included with the product packaging and copies of our instruction manuals are available upon request. Under no circumstances shall Inforesight Consumer Products Inc. or its affiliated entities, employees, agents, shareholders, officers or directors be liable to Customer or any third party for any product installations and Customer releases Inforesight Consumer Products Inc. from any and all losses, death, personal injury, property damage, other damages, rights, claims, demands and actions of any kind arising from the Customer's installation and use of the product, whether the installation was or was not in accord with the provided instruction manual and/or in compliance with applicable local laws.

Due to ongoing product improvements, specifications and dimensions are subject to change without notice and without incurring obligations.

Solaira^o™ is a registered trademark of Inforesight Consumer Products Inc.

125 Traders Blvd. # 4, Mississauga, Ontario, Canada, M4Z 2H3

Tel: 905-568-7655, EXT 23 SERVICE, Fax:905-568-7521

info@solairaheaters.com

Due to ongoing product improvements, specifications and dimensions are subject to change without notice and without incurring obligations.